



■ Vers. 064



■ Vers. 064



■ Vers. 003



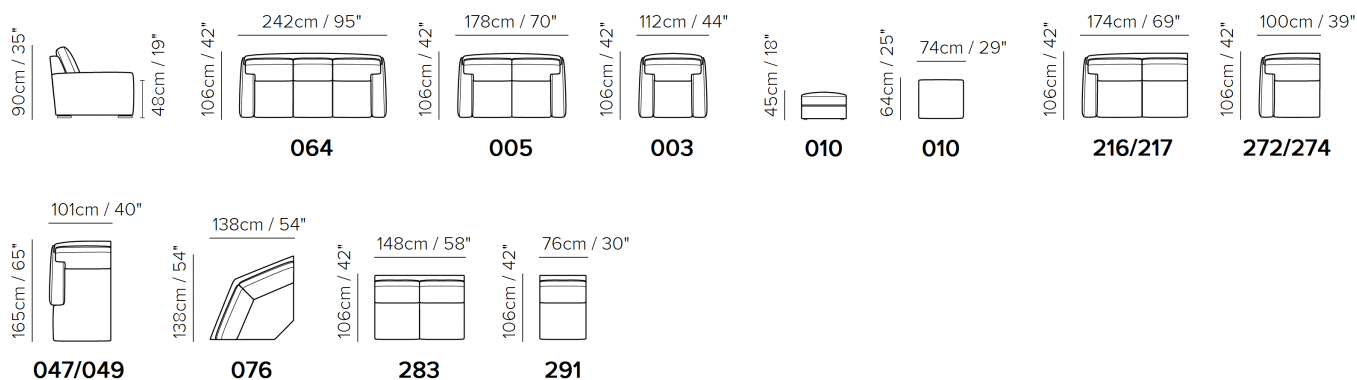

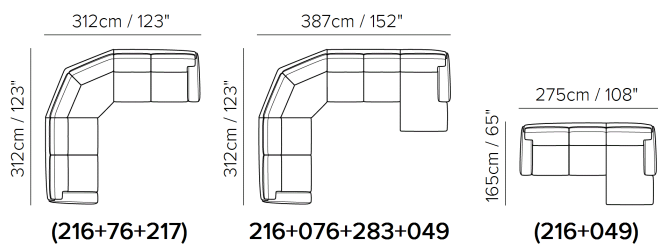

SCHEMATICS



COMPOSITION EXAMPLES



TECHNICAL INFORMATION

| | | | | | | |
|--|-----------------|--|--|--|--------------------------------------|---|
|  | COVERING | Leather <input checked="" type="checkbox"/> | Soft Cover <input checked="" type="checkbox"/> | | | |
|  | LEGS | Wood <input checked="" type="checkbox"/> | Metal <input type="checkbox"/> | Plastic <input type="checkbox"/> | Castors <input type="checkbox"/> | Upholstered <input type="checkbox"/> |
|  | FILLING | Arms <input type="checkbox"/> Fiber <input checked="" type="checkbox"/> Foam <input type="checkbox"/> Feather/Fiber Mix <input type="checkbox"/> Feather | Seat cushion <input type="checkbox"/> Fiber <input checked="" type="checkbox"/> Foam <input type="checkbox"/> Feather/Fiber Mix <input type="checkbox"/> Feather | Back cushion <input checked="" type="checkbox"/> Fiber <input type="checkbox"/> Foam <input type="checkbox"/> Feather/Fiber Mix <input type="checkbox"/> Feather | | |
|  | COMFORT | Firm Comfort <input type="checkbox"/> | Standard Comfort <input checked="" type="checkbox"/> | | | |
|  | FUNCTION | Bed <input type="checkbox"/> | Electric motion <input type="checkbox"/> | Motion <input type="checkbox"/> | Recliner <input type="checkbox"/> | Sliding <input type="checkbox"/> |
|  | OPTIONS | Nails <input type="checkbox"/> | Contrast Stitching <input type="checkbox"/> | Removable <input type="checkbox"/> | | |

NOTES

- Model is available with contrast welt (or any another decorative detail such as a band under arm cushion) to be entered as second covering in the same category.
- All arms, back and seat surfaces are covered in Top Grain.
- This model is available with split leather exterior covering (Side, Rear and Front Panels)
- Loose Seat Cushion (the seat cushions of the model are not fixed to the frame)
- Back Cushion with elastic belt with buckle (the back cushion is attached to the frame through an elastic belt with buckle)
- No Leather Side (the sectional pieces have the side covered with lining and not leather)
- Wood Frame
- Without Feet Assembled (the feet will be in a bag inside the package)
- Plastic Wrap (the model will be wrapped in a plastic bag)
- Feet available in wood finishings 09 (Walnut) / 18 (Wengè)
- Feet height 5,0 cm

NOTES
